



# DIE WELT PRÄZISE SEHEN DURCH FARBIGE GLÄSER

SEIKO FARBEN



ÜBER 200  
FARBEN  
VERFÜGBAR

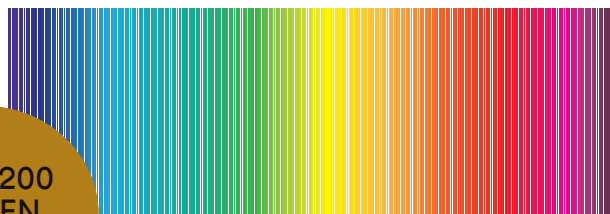

# SEIKO

PRECISION FOR VISION

# SEIKO FARBEN

Ein Regenbogen voller Möglichkeiten

DIESE FARBPALETTE LÄSST KEINE WÜNSCHE OFFEN

Auswahl, soweit das Auge reicht: Die Seiko Farbwelt umfasst mehr als 200 verschiedene Farben und Tönungen für Brillengläser, von kühlem Grau bis zu angesagten Pastelltönen. Für uns der beste Weg, um Brillen einen einzigartigen und individuellen Look zu verleihen.

Höhere Kontraste, intensivere Farben: Seiko Farben bieten ein umfangreiches und modisches Angebot an Farbfiltern und vollfarbigen Brillengläsern in bester Seiko Qualität.

| FARBAUSWAHL  |                | CODE | FARBINTENSITÄT |     |     |     |     |     |     |     |     |          |     |     |     |     |     |     |         |         |
|--------------|----------------|------|----------------|-----|-----|-----|-----|-----|-----|-----|-----|----------|-----|-----|-----|-----|-----|-----|---------|---------|
|              |                |      | VOLLFARBEN     |     |     |     |     |     |     |     |     | VERLÄUFE |     |     |     |     |     |     |         |         |
|              |                |      | 5F             | 10F | 15F | 20F | 25F | 30F | 40F | 50F | 70F | 15G      | 20G | 25G | 30G | 40G | 50G | 70G | 40/10DG | 50/20DG |
| FILTERFARBEN | Neat Brown     | NBR  |                | ●   | ●   | ●   | ●   | ●   | ●   | ●   | ●   | ●        | ●   | ●   | ●   | ●   | ●   | ●   | ●       | ●       |
|              | Shade Brown    | SBR  |                | ●   | ●   | ●   | ●   | ●   | ●   | ●   | ●   | ●        | ●   | ●   | ●   | ●   | ●   | ●   | ●       | ●       |
|              | Warm Brown     | WBR  |                | ●   | ●   | ●   | ●   | ●   | ●   | ●   | ●   | ●        | ●   | ●   | ●   | ●   | ●   | ●   | ●       | ●       |
|              | Gentle Grey    | GGY  |                | ●   | ●   | ●   | ●   | ●   | ●   | ●   | ●   | ●        | ●   | ●   | ●   | ●   | ●   | ●   | ●       | ●       |
|              | Mild Grey      | MGY  |                | ●   | ●   | ●   | ●   | ●   | ●   | ●   | ●   | ●        | ●   | ●   | ●   | ●   | ●   | ●   | ●       | ●       |
|              | Cool Grey      | CGY  |                | ●   | ●   | ●   | ●   | ●   | ●   | ●   | ●   | ●        | ●   | ●   | ●   | ●   | ●   | ●   | ●       | ●       |
|              | Clear Pink     | CPK  | ●              | ●   | ●   | ●   | ●   | ●   | ●   | ●   | ●   | ●        | ●   | ●   | ●   | ●   | ●   | ●   | ●       | ●       |
|              | Mint Green     | CBL  | ●              | ●   | ●   | ●   | ●   | ●   | ●   | ●   | ●   | ●        | ●   | ●   | ●   | ●   | ●   | ●   | ●       | ●       |
|              | Greyish Pink   | GPK  |                | ●   | ●   | ●   | ●   | ●   | ●   | ●   | ●   | ●        | ●   | ●   | ●   | ●   | ●   | ●   | ●       | ●       |
|              | Greyish Purple | GPP  |                | ●   | ●   | ●   | ●   | ●   | ●   | ●   | ●   | ●        | ●   | ●   | ●   | ●   | ●   | ●   | ●       | ●       |
|              | Greyish Blue   | GBL  |                | ●   | ●   | ●   | ●   | ●   | ●   | ●   | ●   | ●        | ●   | ●   | ●   | ●   | ●   | ●   | ●       | ●       |

|               |                | CODE | 10F | 15F | 20F | 25F | 65F | 70F | 75F | 80F | 85F | 15G | 20G | 25G | 30G | 40G | 50G | 70G | 65/20DG | 75/30DG | 85/40DG |   |
|---------------|----------------|------|-----|-----|-----|-----|-----|-----|-----|-----|-----|-----|-----|-----|-----|-----|-----|-----|---------|---------|---------|---|
| PASTELL       | Citrus Yellow  | CYL  |     | ●   |     |     |     |     |     |     |     |     |     |     |     |     |     |     |         |         |         |   |
|               | Sherbet Orange | SOR  |     | ●   |     |     |     |     |     |     |     |     |     |     |     |     |     |     |         |         |         |   |
|               | Ice Blue       | IBL  |     | ●   |     |     |     |     |     |     |     |     |     |     |     |     |     |     |         |         |         |   |
| BLUE-BLOCKER  | Sky Fun        | SOSK |     |     |     |     |     | ●   |     |     |     |     |     |     |     |     |     |     |         |         |         |   |
|               | Road Star      | SORS |     |     |     |     |     |     |     |     | ●   |     |     |     |     |     |     |     |         |         |         |   |
|               | Sunny Yellow   | SYL  |     |     | ●   |     |     |     |     |     |     |     |     |     |     |     |     |     |         |         |         |   |
| SUN           | Brown          | SOBR |     |     |     |     | ●   |     | ●   |     | ●   |     |     |     |     |     |     |     |         | ●       | ●       | ● |
|               | Grey           | SOGR |     |     |     |     | ●   |     | ●   |     | ●   |     |     |     |     |     |     |     |         | ●       | ●       | ● |
|               | Green          | SOGN |     |     |     |     | ●   |     | ●   |     | ●   |     |     |     |     |     |     |     |         | ●       | ●       | ● |
|               | Deep Grey      | DGY  |     |     |     |     |     |     |     |     | ●   |     |     |     |     |     |     |     |         |         |         |   |
|               | Deep Brown     | DBR  |     |     |     |     |     |     |     |     | ●   |     |     |     |     |     |     |     |         |         |         |   |
|               | Deep Green     | DGN  |     |     |     |     |     |     |     |     | ●   |     |     |     |     |     |     |     |         |         |         |   |
|               | RB-Green       | SORB |     |     |     |     |     |     |     |     | ●   |     |     |     |     |     |     |     |         |         |         |   |
|               | Ocean Blue     | OBL  |     |     |     |     |     |     | ●   |     |     |     |     |     |     |     |     |     |         |         |         |   |
| POLARISIEREND | Brown          |      |     |     |     |     |     |     |     |     | ●   |     |     |     |     |     |     |     |         |         |         |   |
|               | Grey           |      |     |     |     |     |     |     |     |     | ●   |     |     |     |     |     |     |     |         |         |         |   |
|               | Green          |      |     |     |     |     |     |     |     |     | ●   |     |     |     |     |     |     |     |         |         |         |   |
| MIRROR        | Gold           | MGS  |     |     |     |     |     |     |     |     |     |     |     |     |     |     |     |     |         |         |         |   |
|               | Silver         | MSS  |     |     |     |     |     |     |     |     |     |     |     |     |     |     |     |     |         |         |         |   |
|               | Blue           | MBS  |     |     |     |     |     |     |     |     |     |     |     |     |     |     |     |     |         |         |         |   |
|               | Red            | MRS  |     |     |     |     |     |     |     |     |     |     |     |     |     |     |     |     |         |         |         |   |
|               | Green          | MNS  |     |     |     |     |     |     |     |     |     |     |     |     |     |     |     |     |         |         |         |   |

● Verfügbare Farbintensität ■ Nicht nachfahrtauglich F = Vollfarbe | G = Verlauf | DG = Doppelverlauf

# SEIKO FARBVER- LÄUFE

## STANDARD

### BEGINN FARBVERLAUF

- Gleitsicht: ab Höhe Glashorizontale

### VERLAUFLÄNGE 10mm



Abb. nicht maßstabsgetreu

Seiko bietet Ihnen die Möglichkeit, die Lage und die Länge des Verlaufs individuell zu gestalten.

### a) Lage des Verlaufs

Standardmäßig beginnt der Verlauf auf Höhe der Glashorizontale (Gleitsicht) bzw. OM/BZ (Einstärken)

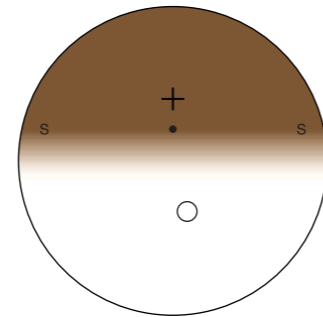
Wenn Sie eine andere Verlaufslage wünschen, wählen Sie zwischen folgenden Optionen und teilen Sie uns diese per Kommentar bei der Bestellung mit:

- Verlauf mittig
- Verlauf zwei Drittel / ein Drittel
- Verlauf drei Viertel / ein Viertel
- Verlauf XY mm tiefer (DN) / höher (UP) als Glashorizontale

Siehe Hinweis Seite 5

### b) Verlaufsänge

Standardmäßig hat unser Verlauf eine Länge von 10mm.

Wenn der Verlauf länger (= weicher) oder härter (= kürzer) sein soll, teilen Sie uns die gewünschte Länge mit:

- Verlaufsänge XY mm

Siehe Hinweis Seite 5

## SEIKO FARBVERLÄUFE – SO INDIVIDUELL WIE IHRE KUNDEN

### LÄNGER / KÜRZER

#### LÄNGER

- Bis maximal **20 mm**
- In 1 mm Schritten

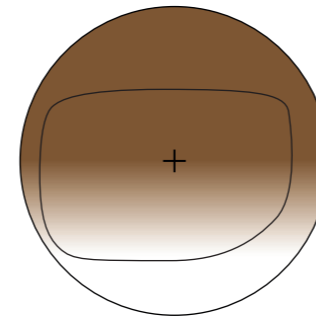

#### KÜRZER

- Bis minimal **5 mm**
- In 1 mm Schritten

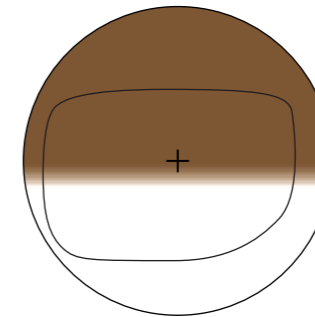

### TIEFER / HÖHER

#### AUF WUNSCH TIEFER

- In 1 mm Schritten

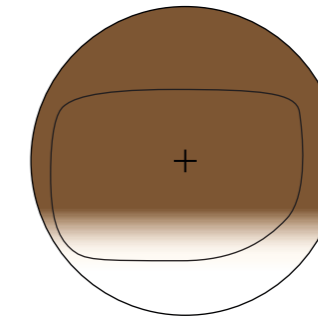





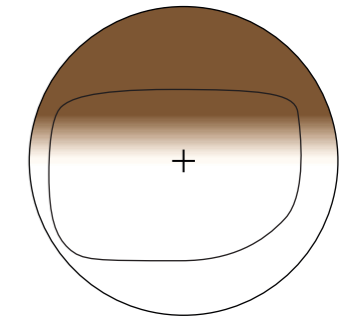







































































































#### AUF WUNSCH HÖHER

- In 1 mm Schritten



## HINWEISE ZUR BESTELLUNG – ABKÜRZUNGEN

|   | ABKÜRZUNG   |
|---|---|
| Verlaufsänge XX mm                        | Sample VL XX mm   |
| Verlauf tiefer XX mm (down)               | Sample DN XX mm   |
| Verlauf höher XX mm (up)                  | Sample UP XX mm   |
| Kombination Verlaufsänge und höher/tiefer | Sample VL XX mm DN XX mm oder<br>Sample VL XX mm UP XX mm |

| EINFARBIG | Neat Brown   | Shade Brown  | Warm Brown   | Gentle Grey  | Mild Grey  | Cool Grey  | Neat Brown   | Shade Brown  | Warm Brown   | Gentle Grey  | Mild Grey  | Cool Grey  | VERLAUF |
|-----------|--|--|--|--|--|--|--|--|--|--|--|--|---------|
| 10%       | <br>NBR 10F   | <br>SBR 10F   | <br>WBR 10F   | <br>GGY 10F   | <br>MGY 10F   | <br>CGY 10F   | <br>NBR 15G       | <br>SBR 15G       | <br>WBR 15G       | <br>GGY 15G       | <br>MGY 15G       | <br>CGY 15G       | 15/0%   |
| 15%       | <br>NBR 15F   | <br>SBR 15F   | <br>WBR 15F   | <br>GGY 15F   | <br>MGY 15F   | <br>CGY 15F   | <br>NBR 20G       | <br>SBR 20G       | <br>WBR 20G       | <br>GGY 20G       | <br>MGY 20G       | <br>CGY 20G       | 20/0%   |
| 20%       | <br>NBR 20F   | <br>SBR 20F   | <br>WBR 20F   | <br>GGY 20F   | <br>MGY 20F   | <br>CGY 20F   | <br>NBR 25G       | <br>SBR 25G       | <br>WBR 25G       | <br>GGY 25G       | <br>MGY 25G       | <br>CGY 25G       | 25/0%   |
| 25%       | <br>NBR 25F   | <br>SBR 25F   | <br>WBR 25F   | <br>GGY 25F   | <br>MGY 25F   | <br>CGY 25F   | <br>NBR 30G       | <br>SBR 30G       | <br>WBR 30G       | <br>GGY 30G       | <br>MGY 30G       | <br>CGY 30G       | 30/0%   |
| 30%       | <br>NBR 30F   | <br>SBR 30F   | <br>WBR 30F   | <br>GGY 30F   | <br>MGY 30F   | <br>CGY 30F   | <br>NBR 40G       | <br>SBR 40G       | <br>WBR 40G       | <br>GGY 40G       | <br>MGY 40G       | <br>CGY 40G       | 40/0%   |
| 40%       | <br>NBR 40F   | <br>SBR 40F   | <br>WBR 40F   | <br>GGY 40F   | <br>MGY 40F   | <br>CGY 40F   | <br>NBR 50G       | <br>SBR 50G       | <br>WBR 50G       | <br>GGY 50G       | <br>MGY 50G       | <br>CGY 50G       | 50/0%   |
| 50%       | <br>NBR 50F  | <br>SBR 50F  | <br>WBR 50F  | <br>GGY 50F  | <br>MGY 50F  | <br>CGY 50F  | <br>NBR 70G      | <br>SBR 70G      | <br>WBR 70G      | <br>GGY 70G      | <br>MGY 70G      | <br>CGY 70G      | 70/0%   |
| 70%       | <br>NBR 70F | <br>SBR 70F | <br>WBR 70F | <br>GGY 70F | <br>MGY 70F | <br>CGY 70F | <br>NBR 40/10DG | <br>SBR 40/10DG | <br>WBR 40/10DG | <br>GGY 40/10DG | <br>MGY 40/10DG | <br>CGY 40/10DG | 40/10%  |
|           |  |  |  |  |  |  | <br>NBR 50/20DG | <br>SBR 50/20DG | <br>WBR 50/20DG | <br>GGY 50/20DG | <br>MGY 50/20DG | <br>CGY 50/20DG | 50/20%  |
|           |  |  |  |  |  |  | <br>NBR 70/20DG | <br>SBR 70/20DG | <br>WBR 70/20DG | <br>GGY 70/20DG | <br>MGY 70/20DG | <br>CGY 70/20DG | 70/20%  |

F = Vollfarbe | G = Verlauf | DG = Doppelverlauf

| EINFARBIG |  |  |  |  |  |  |  |  |  |  | VERLAUF |
|-----------|--|--|--|--|--|--|--|--|--|--|---------|
|           | Clear Pink   | Mint Green   | Greyish Pink   | Greyish Purple   | Greyish Blue   | Clear Pink   | Mint Green   | Greyish Pink   | Greyish Purple   | Greyish Blue   |         |
| 5%        | <br>CPK 5F    | <br>CBL 5F    |  |  |  | <br>CPK 15G       | <br>CBL 15G       | <br>GPK 15G       | <br>GPP 15G       | <br>GBL 15G       | 15/0%   |
| 10%       | <br>CPK 10F   | <br>CBL 10F   | <br>GPK 10F   | <br>GPP 10F   | <br>GBL 10F   | <br>CPK 20G       | <br>CBL 20G       | <br>GPK 20G       | <br>GPP 20G       | <br>GBL 20G       | 20/0%   |
| 15%       | <br>CPK 15F   | <br>CBL 15F   | <br>GPK 15F   | <br>GPP 15F   | <br>GBL 15F   | <br>CPK 25G       | <br>CBL 25G       | <br>GPK 25G       | <br>GPP 25G       | <br>GBL 25G       | 25/0%   |
| 20%       | <br>CPK 20F   | <br>CBL 20F   | <br>GPK 20F   | <br>GPP 20F   | <br>GBL 20F   | <br>CPK 30G       | <br>CBL 30G       | <br>GPK 30G       | <br>GPP 30G       | <br>GBL 30G       | 30/0%   |
| 25%       | <br>CPK 25F   | <br>CBL 25F   | <br>GPK 25F   | <br>GPP 25F   | <br>GBL 25F   | <br>CPK 40G       | <br>CBL 40G       | <br>GPK 40G       | <br>GPP 40G       | <br>GBL 40G       | 40/0%   |
| 30%       | <br>CPK 30F   | <br>CBL 30F   | <br>GPK 30F   | <br>GPP 30F   | <br>GBL 30F   | <br>CPK 50G       | <br>CBL 50G       | <br>GPK 50G       | <br>GPP 50G       | <br>GBL 50G       | 50/0%   |
| 40%       | <br>CPK 40F  | <br>CBL 40F  | <br>GPK 40F  | <br>GPP 40F  | <br>GBL 40F  |  |  | <br>GPK 70G      | <br>GPP 70G      | <br>GBL 70G      | 70/0%   |
| 50%       | <br>CPK 50F | <br>CBL 50F | <br>GPK 50F | <br>GPP 50F | <br>GBL 50F | <br>CPK 40/10DG | <br>CBL 40/10DG | <br>GPK 40/10DG | <br>GPP 40/10DG | <br>GBL 40/10DG | 40/10%  |
| 70%       |  |  | <br>GPK 70F | <br>GPP 70F | <br>GBL 70F | <br>CPK 50/20DG | <br>CBL 50/20DG | <br>GPK 50/20DG | <br>GPP 50/20DG | <br>GBL 50/20DG | 50/20%  |
| 10/0%     | <br>CPK 10G | <br>CBL 10G |  |  |  |  |  | <br>GPK 70/20DG | <br>GPP 70/20DG | <br>GBL 70/20DG | 70/20%  |

SEIKO PASTELL-FARBEN

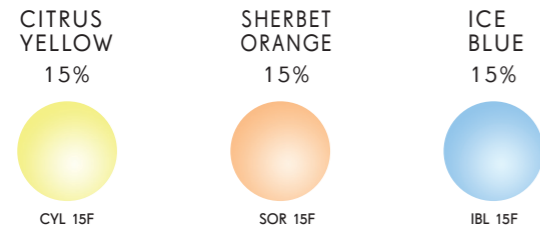

SEIKO BLUE-BLOCKER

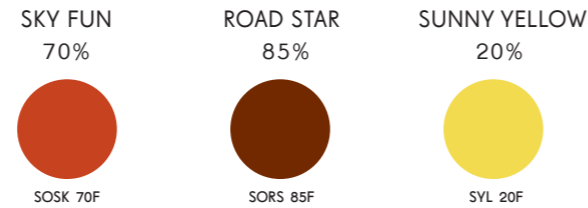

SEIKO SUN

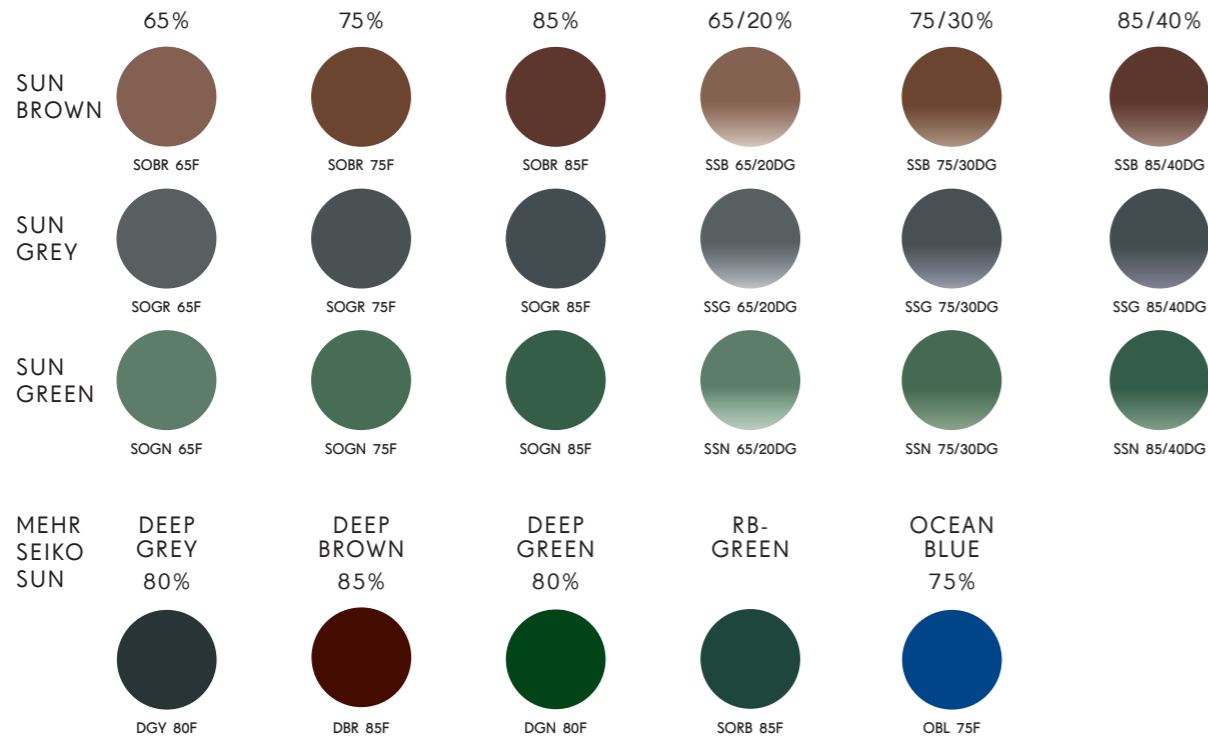

SEIKO POLARISIEREND

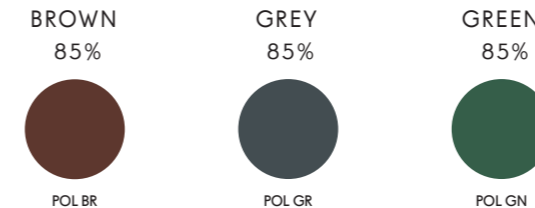

SEIKO MIRROR

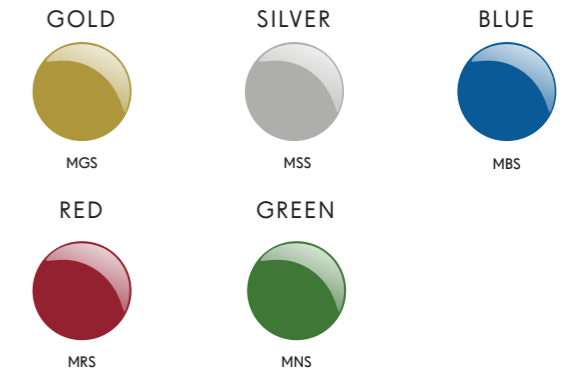

TECHNISCHE INFORMATION

Jede Tönung wird durch das verwendete Material, der Beschichtung, den unterschiedlichen Lichtverhältnissen und der individuellen Farbwahrnehmung beeinflusst. Die in dieser Broschüre abgebildeten Farben können vom tatsächlichen Muster abweichen.

| Absorption % | Kategorie | Einschränkungen        |
|--------------|-----------|------------------------|
| 0 – 19       | 0         | Keine                  |
| 20 – 56      | 1         | Nicht nachfahrtauglich |
| 57 – 81      | 2         | Nicht nachfahrtauglich |
| 82 – 91      | 3         | Nicht nachfahrtauglich |
| 92 – 97      | 4         | Nicht verkehrstauglich |

# SEIKO

PRECISION FOR VISION

## HERAUSGEBER

Seiko Optical Europe GmbH  
Dohrweg 42 | 41066 Mönchengladbach  
Tel: +49(0)21 61 – 65 22 – 555  
[info.germany@seikovision.com](mailto:info.germany@seikovision.com)  
[www.seikovision.com](http://www.seikovision.com)

## ALLE RECHTE VORBEHALTEN

Nachdruck und Verwendung, auch auszugsweise, nur mit ausdrücklicher und schriftlicher Genehmigung des Herausgebers.